

HyperRapid NXT

Picosecond Lasers for Industrial Micromachining with Maximum Flexibility

HyperRapid NXT is Coherent's new high power industrial picosecond laser platform, and the benchmark for industrial micromachining applications.

HyperRapid NXT features a compact and modular design with an identical footprint and electronic interfacing for all power levels and wavelengths.

Its unique combination of highest laser power and operational flexibility enables optimum process performance under all circumstances: High average power levels deliver high throughput and minimize cost-per-part while flexibility in repetition rate and pulse energy result in excellent quality.

The HyperRapid NXT product is backed up with worldwide service support to match the most demanding uptime and cost-of-ownership requirements.



FEATURES & BENEFITS

- Single wavelength output: 1064 nm, 532 nm, or 355 nm
- Unique combination of power and operational flexibility delivers significantly reduced cost-per-part for micromachining applications
- SmartPulse™ offers total pulse control to the user
- PulseEQ provides equal, perfectly stabilized pulse energy down to single shots with maximum timing accuracy
- Compact and light weight, common interfacing for all models
- Many product support options to optimize uptime and cost-of-ownership

APPLICATIONS

- Cutting and drilling of glass, sapphire, ceramics, and other brittle materials and composites at highest speeds
- Cutting, drilling, selective removal of complex composite structures from dissimilar materials, including oxides, plastics, and organics
- Micromachining and structuring of large surfaces with line focusing or multiple beams



SPECIFICATIONS ^{1,2,3,4}	HyperRapid NXT						
	1064-50	532-25	355-15	1064-100	532-50	355-30	355-30 HRR
Single Wavelength Output (nm)	1064	532	355	1064	532	355	355
Power ⁵ (W)	50	25	15	100	50	30	30
Pulse Repetition Rate Range (kHz)	Single-Shot to 4000						
Pulse Duration (ps)	<15	<15	<10	<15	<15	<10	<10
Average Power Stability ⁶ (RMS 1 σ ,%)	≤ 1						
Maximum Pulse Energy (μ J)	220	125	75	250	125	75	37
Pulse-to-Pulse Energy Stability ⁸ (RMS 1 σ , %)	≤ 1	≤ 2	≤ 2	≤ 1	≤ 2	≤ 2	≤ 2
PulseEQ Triggering (kHz)	Single-Shot to 1600						
Beam Quality Parameter (M ²)	≤ 1.3						
Beam Diameter, 1 m in front of laser (mm)	5.0 \pm 0.5						
Beam Divergence, full angle (mrad)	≤ 1						
Beam Circularity, 1 m in front of laser (%)	≥ 85						
Beam-Pointing Stability (μ rad/ $^{\circ}$ C)	≤ 50 (peak-to-peak)						
Bore Sight Accuracy							
Lateral (mm) (beam to specified exit location)	≤ 1						
Angular (mrad) (beam to specified exit direction)	≤ 5						
Direction of Polarization (Vertical/Horizontal)	V	H	H	V	H	H	H
Polarization Ratio	>100:1						
Warm-up Time from Chiller Start (minutes)	<45						
Electrical Supply	100 to 230V AC/50 to 60 Hz/2.5 kW						
Mounting Orientation	Horizontal						
Chiller	Water-to-Air or Water-to-Water						
Dimensions							
Laser Head	600 x 780 x 245 mm (23.6 x 30.7 x 9.6 in.)						
Power Supply	3U 19" rack						
SMC Chiller	500 x 317 x 615 mm (19.7 x 12.5 x 24.2 in.)						
Weight							
Laser Head	≤ 67 kg (147.7 lbs.)						
Power Supply	16 kg (35.3 lbs.)						
SMC Chiller	43 kg (94.8 lbs.)						
BURST MODE OPERATION							
Burst Mode Operation Range (kHz)	Single-Shot to 1600						
Total Energy in the Burst ⁷ (μ J)	500	N/A	N/A	500	N/A	N/A	N/A
Maximum Number of Pulses in Burst ⁸	10						
OPERATING SPECIFICATIONS							
Allowed Temperature Range During Operation	+15 $^{\circ}$ C to +30 $^{\circ}$ C (free of condensation)						
Humidity (%)	0 to 90 RH, non-condensing, Dew-point <22 $^{\circ}$ C						

1 Due to our continuous product improvement program, specifications may change without notice.

2 After warm-up time, chiller temperature = 23 \pm 0.1 $^{\circ}$ C.

3 Steady-state (no pulse gating or change of pulse repetition rate).

4 Single-pulse operation (burst number = 1).

5 Maximum power with variable attenuator and process shutter at maximum transmission.

6 Over 8 hours, $\pm 1^{\circ}$ C ambient temperature.

7 With 5 pulses in the burst, at the lowest burst mode operation range frequency.

8 (Pulse repetition rate) x (number of burst) cannot exceed 5 MHz.

TYPICAL PERFORMANCE DATA

HyperRapid NXT
Typical Single Pulse Energy Output

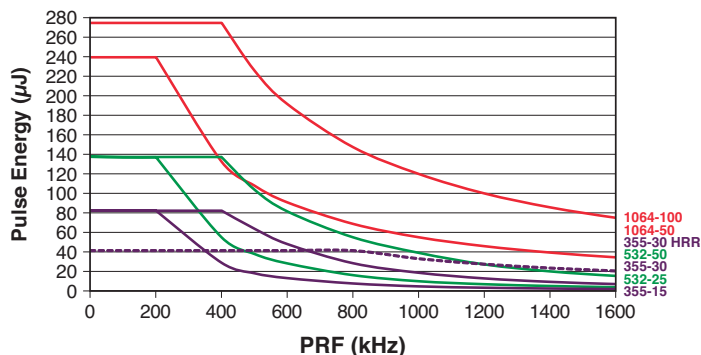

HyperRapid NXT
Typical Power Output

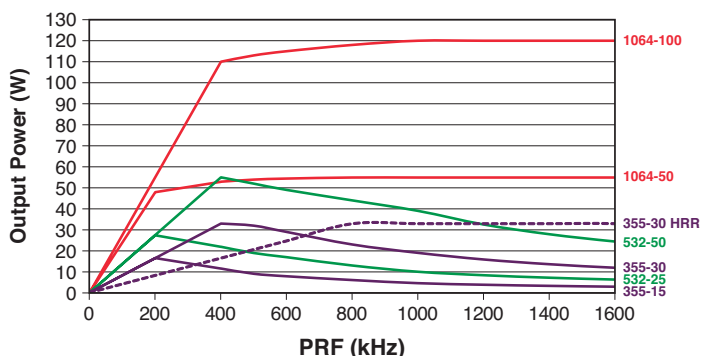

HyperRapid NXT
Typical Power Output

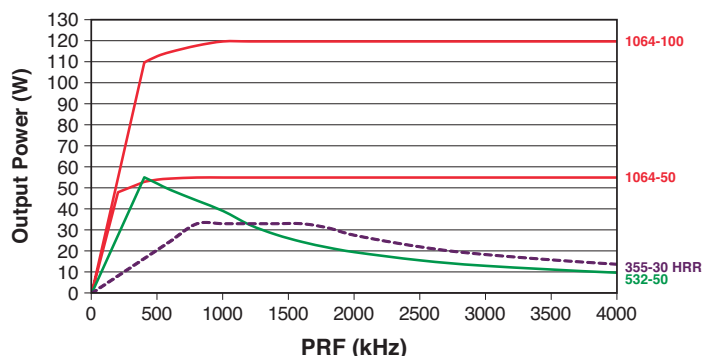

SmartPulse™ Offers Maximum Flexibility

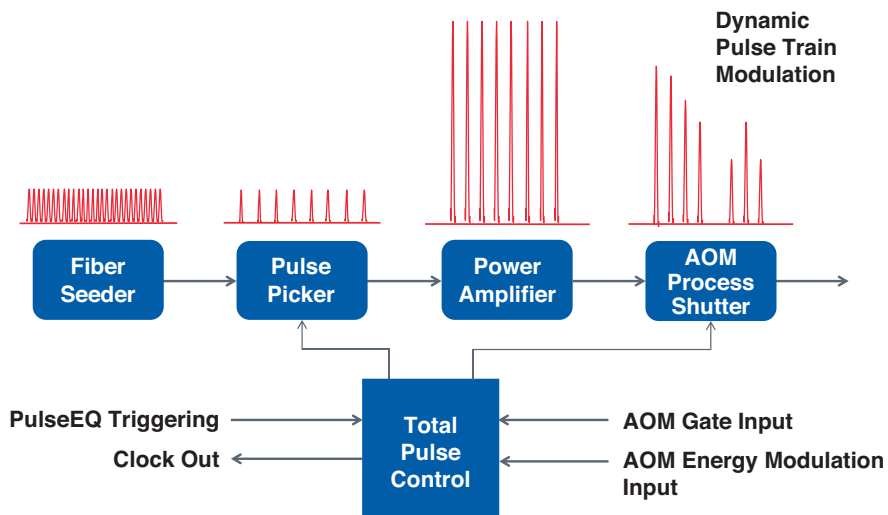

MECHANICAL SPECIFICATIONS

HyperRapid NXT

Bottom View

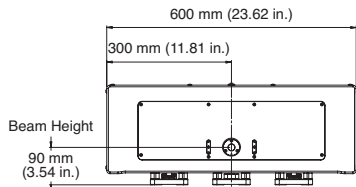
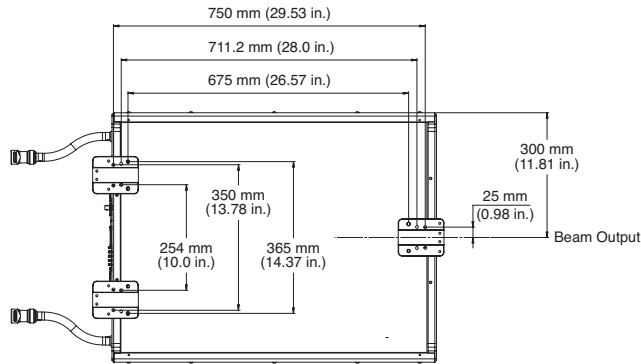

Front View

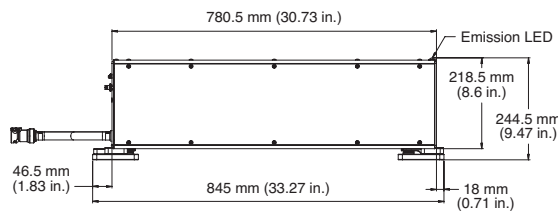

Side View

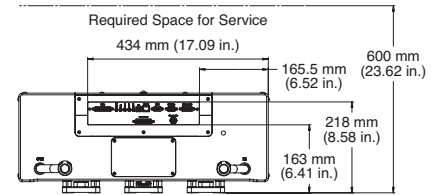

Rear View

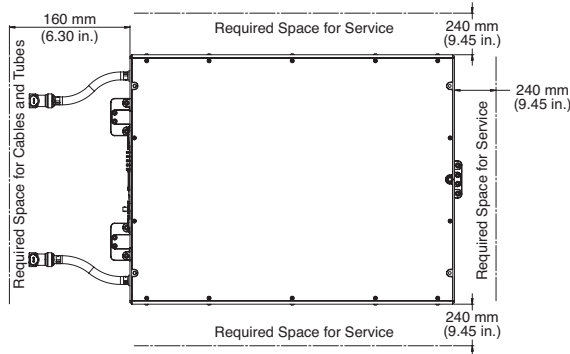

Top View



Coherent, Inc.,
 5100 Patrick Henry Drive Santa Clara, CA 95054
 p. (800) 527-3786 | (408) 764-4983
 f. (408) 764-4646

tech.sales@coherent.com www.coherent.com

Coherent follows a policy of continuous product improvement. Specifications are subject to change without notice.

Coherent offers a limited warranty for all HyperRapid NXT Lasers. For full details of this warranty coverage, please refer to the Service section at www.coherent.com or contact your local Sales or Service Representative. MC-023-19-0M0220Rev.A Copyright ©2020 Coherent, Inc.

