

BC43

The Ultimate Benchtop Microscope Family

Key Features

- ✓ Benchtop multimodal imaging system
- ✓ Instant confocal: Blur-free imaging
- ✓ Widefield imaging
- ✓ Differential phase contrast & brightfield
- ✓ Guaranteed optical performance
- ✓ Super resolution ready
- ✓ In-field upgradable imaging modes

Key Applications

- ✓ Cell biology
- ✓ Developmental biology
- ✓ Neuroscience
- ✓ Cancer biology
- ✓ Tissue imaging
- ✓ Organoids & large organisms
- ✓ Microbiology



Andor Benchtop Microscope

A Microscopy System that Grows with Your Research

1 **Advanced imaging technology**
Sharp 2D & 3D images instantly.

2 **Enhanced visualisation software**
Intuitive and powerful. Achieve outstanding results quickly with minimal training.

3 **NEW** **Easy super resolution**
Push past the diffraction limit to reveal the inner workings of the cell

4 **Easy to use**
Ergonomic joystick and 2x objective allow quick sample overview.

5 **NEW** **In-field upgradeable**
BC43 provides an upgrade path from widefield fluorescence to confocal to super resolution.

6 **Flexible**
Confocal, widefield and transmitted light imaging modes to suit your experiment.

7 **Optimal performance**
Multidimensional experiments possible. Patented Focus Seek & Lock ensures accuracy in acquisition. Patented Borealis ensures uniform illumination for seamless stitching.

8 **Benchtop design**
Light tight lid and inbuilt anti-vibration, so no need for a darkroom or optical table.

Andor Benchtop Microscope

Total Imaging Flexibility

✓ Widefield Imaging

The most commonly used fluorescence imaging method and often the tool used by researchers new to microscopy. Perfect for live sample imaging, low signals and high-productivity. Most compatible with thinner samples and ClearView deconvolution can be added to remove haze in thicker samples.

✓ Transmitted Light Imaging

BC43 offers two transmitted light options: **Brightfield** for samples with inherent contrast like larger organisms, and **Differential Phase Contrast (DPC)**, that can be applied for samples which deliver high and low contrast.

✓ ClearView™ GPU

ClearView GPU powered deconvolution removes the natural out-of-focus haze from your widefield image for optimal image quality and resolution. Useful in samples up to around 50 microns thick (varies with sample preparation and its optical properties).

✓ Confocal Imaging

Confocal technology provides high-contrast, blur-free images. It boosts image quality of thin samples, such as monolayer cultures, and is especially suited for thick samples like small model organisms, 3D cultures and cleared tissues. BC43 captures images at least 10x faster than point scanning confocals, boosting productivity, yet maintaining full resolution. Image deeper with higher quality than solutions that rely on computational clearing or deconvolution alone.

Until now confocal has been too expensive and complex for many. BC43 is revolutionary – a confocal at the heart of your lab at an affordable price with no expertise required!

✓ Super Resolution Imaging

BC43 provides accessible super resolution imaging - whatever your research discipline. Push through the diffraction barrier to reveal the inner workings of the cell. Whether you want to study the cytoskeleton in enhanced detail, or gain greater insights into specific cellular processes, super resolution is easy to add to your existing imaging workflow.

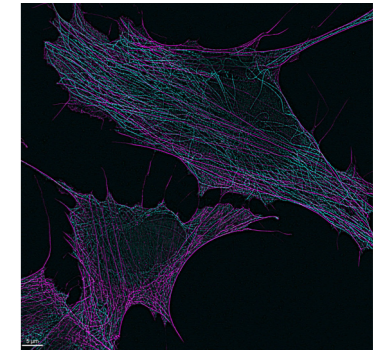
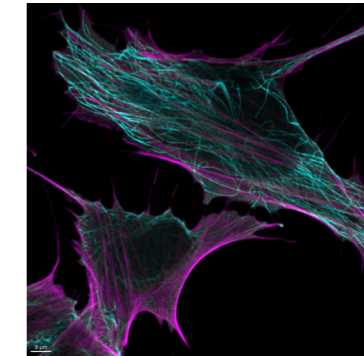
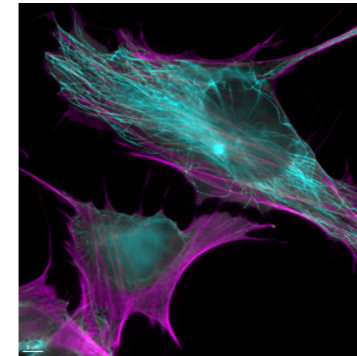
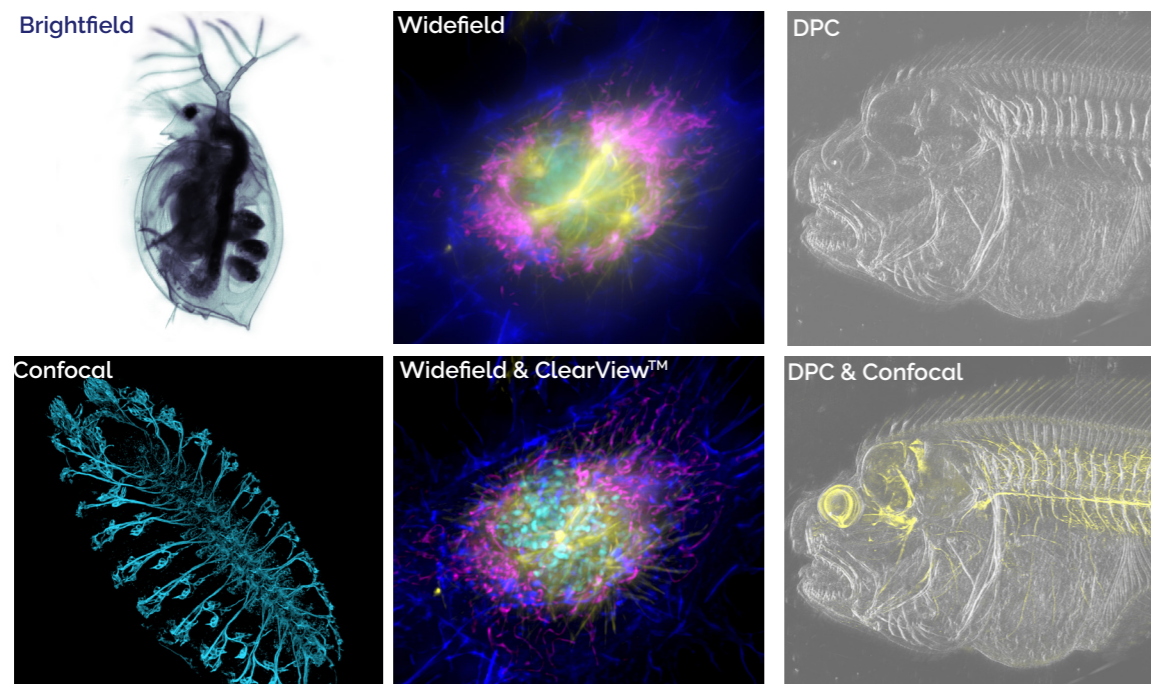

BM42 or BC43 WF



BC43 CF



BC43 SR

Brightfield - White light transmitted light monochrome imaging		
Differential Phase Contrast - High contrast label-free imaging		
Widefield epifluorescence - Routine fluorescence imaging		
Motorised XYZ - Multipoint large area montages & volume acquisition		
	Confocal - Deep 3D fluorescence imaging	
		Super resolution

ClearView™ - haze removal
Confocal - Deep 3D*
Super resolution

Super resolution

Key

- Common Features
- Specific Features
- Upgrade options
- *BC43 WF only

Application Focus

Developmental Biology

BC43 cuts through the challenges easily, spanning development from the first rounds of cell division to the fully developed organism. Use BC43 to image at depth, in gentle live imaging experiments of cells and tissues. Effortlessly acquire multiple Z stacks, multiple tiles in combination with time-lapse imaging.

BC43 delivers fast high-resolution imaging of developing model organisms (e.g. zebrafish and drosophila). Imaging deeper than conventional fluorescence microscopes and delivering a 10-fold more productive experience than a traditional confocal. No sacrificing sensitivity, resolution or 3D detail for speed, or to avoid bleaching.

BC43 features for development biology:

- ✓ Fast high-resolution imaging.
- ✓ Image deep in both live and fixed samples.
- ✓ Montage & seamless stitching at any level of magnification.

"I found BC43 super easy to setup for all my experiments and super fast to acquire and deliver high-quality data. I love its flexibility."

*Marco Campinho,
Group Leader CBMR- UAlg.*

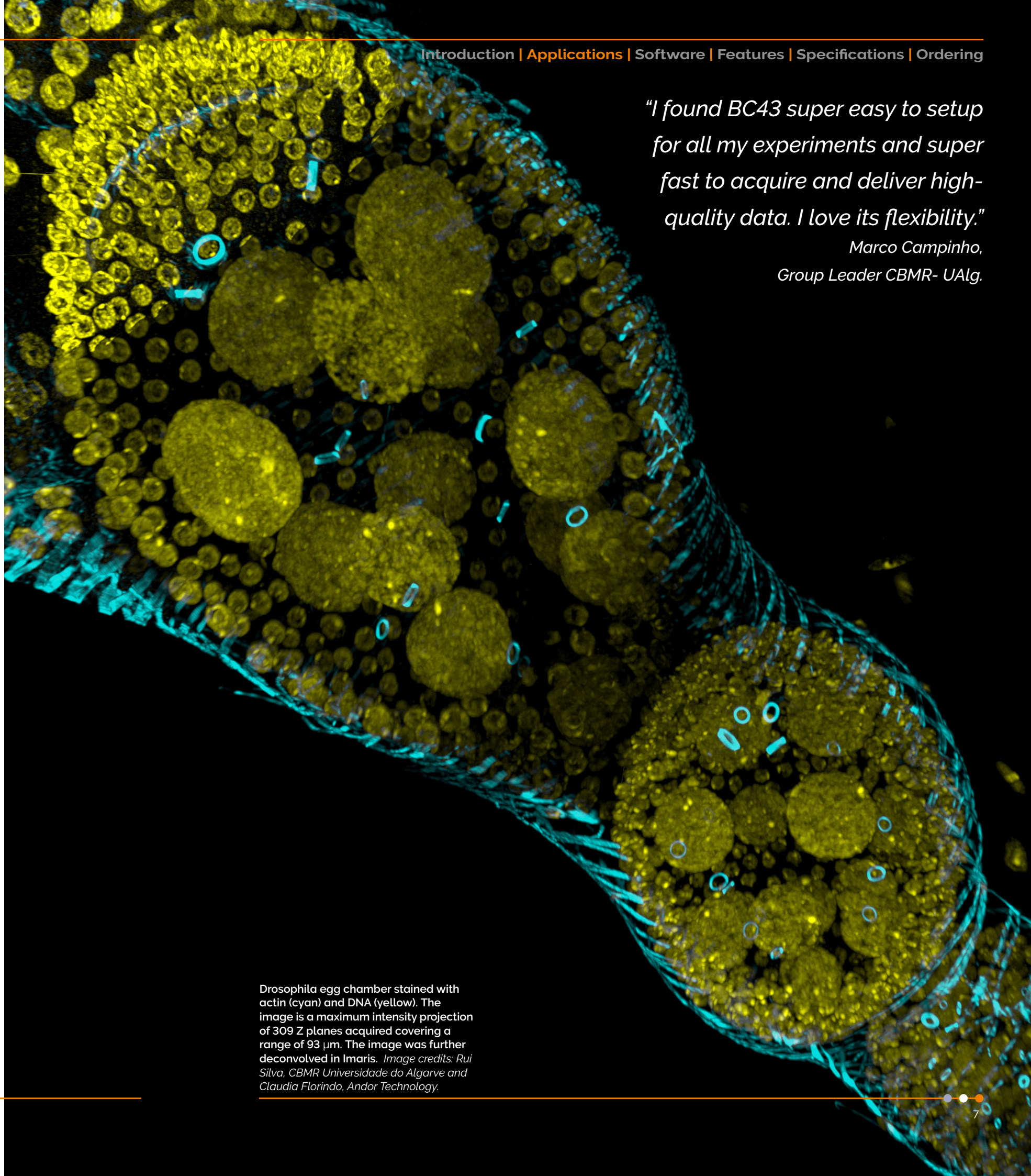

Drosophila egg chamber stained with actin (cyan) and DNA (yellow). The image is a maximum intensity projection of 309 Z planes acquired covering a range of 93 μm . The image was further deconvolved in Imaris. Image credits: Rui Silva, CBMR Universidade do Algarve and Claudia Florindo, Andor Technology.

Application Focus

Cell Biology

Working closely with leading cell biologists we have carefully developed BC43 to meet the needs of a broad range of experiments. Reveal the detail inside cells from nm to mm within tissues and whole model organisms with BC43. Use BC43 in confocal mode to see detail hidden in the sample background or image in widefield to increase sensitivity and speed.

Image fast dynamic events, such as microtubule dynamics, or study longer processes like cell cycle over 24 hours with no photobleaching or phototoxicity.

BC43 features for cell biology:

- ✓ Image long processes.
- ✓ Image fast dynamic events.
- ✓ No photobleaching or phototoxicity.
- ✓ nm to mm imaging capability.



Zebrafish fin in the process of bone regeneration. Confocal image shows the perfect stitching of 4 imaging fields, using three channels and 51 stacks for each field, covering a Z range of 174 µm. Newly formed bony tissue in purple (calcein staining) and cathepsin k⁺ cells (the osteoclasts) in yellow, DNA is in Cyan. *Image credit: Alessio Carletti, Universidade do Algarve.*

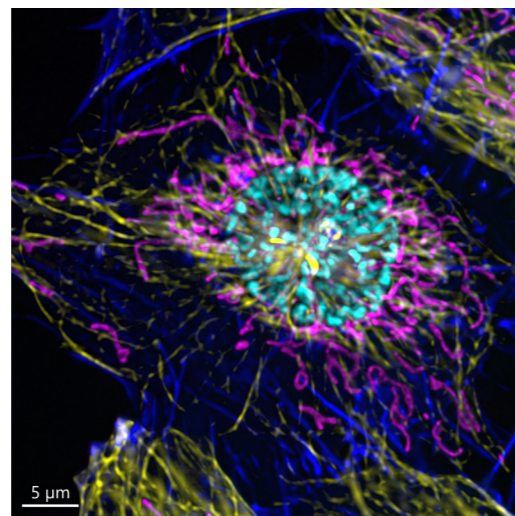

Mammalian cell in prophase. Image was acquired using BC43 confocal mode, using 4 acquisition channels and covering 10 µm Z range at Nyquist. Image was further deconvolved and rendered in Imaris. Dark blue - actin, yellow - microtubules, magenta - mitochondria, cyan-DNA. *Image credit: Claudia Florindo, Andor Technology.*

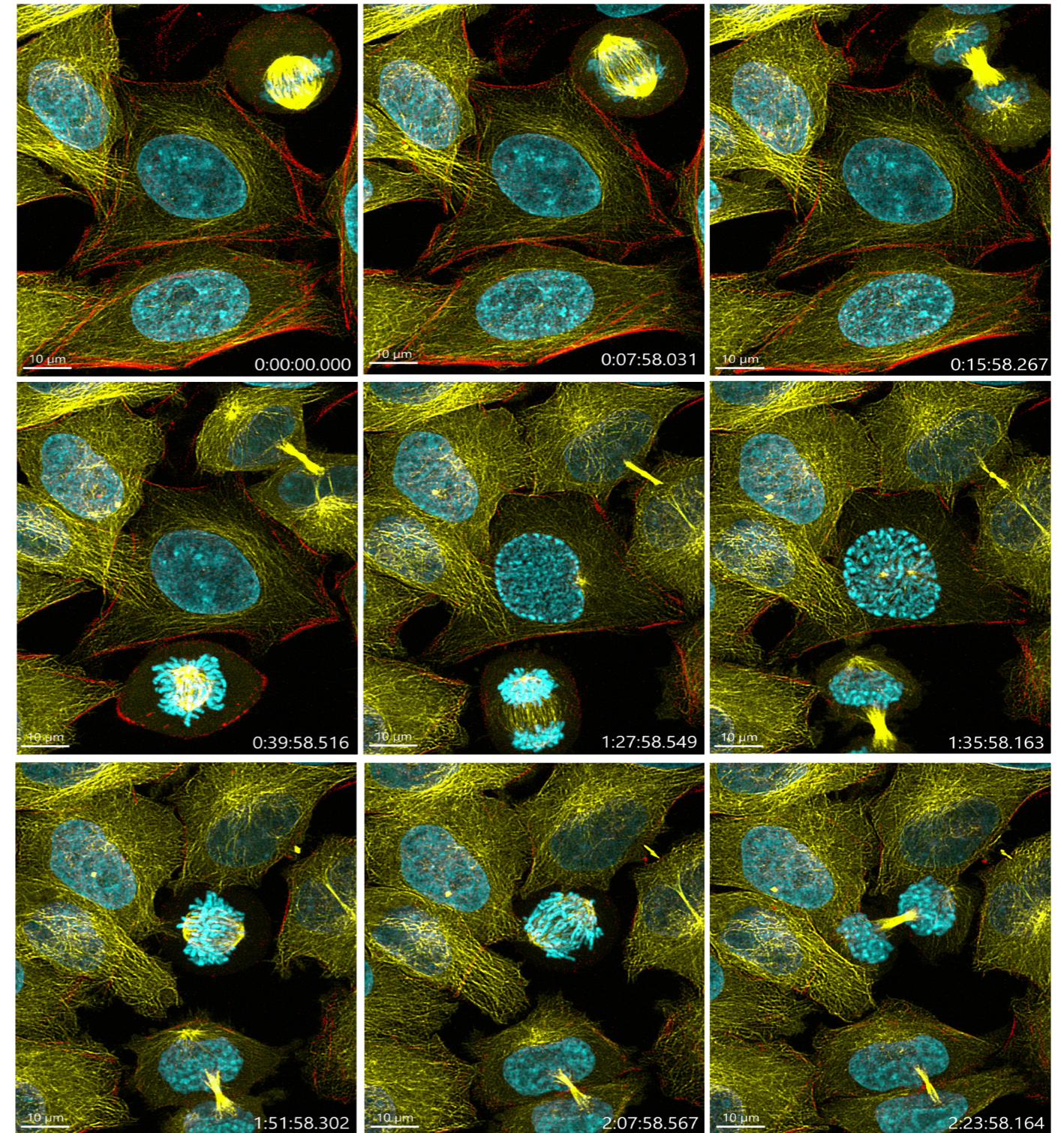

Cell division. Mammalian cells imaged with BC43 using confocal imaging mode for over 4 h. At each time point, 4 independent positions were imaged and for each position 3 channels and 15 Z stacks acquired. Images from one of the 4 positions. Cells undergoing mitosis during the course of the imaging. Red-actin, yellow-microtubules, DNA-cyan.

Image credits: Ines Baião-Santos and Álvaro Tavares, Universidade do Algarve, Claudia Florindo, Andor Technology.

Application Focus

Tissue Imaging

Large area imaging needs to provide both cellular resolution and the full organ context. The advanced high-speed technology in BC43 means you no longer need to compromise. Large area tissue confocal imaging is now possible. Ten times faster than regular confocals. No sacrifices in resolution, or field of view. BC43 delivers results **fast, shortening the time to publication.**

Discover more in intact tissues, use cleared samples and BC43 in confocal mode to image even thicker samples. BC43 takes advantage of the working distance of modern objectives: imaging hundreds of microns at high magnifications, and beyond.

BC43 features for tissue imaging:

- ✓ Fast confocal and low light widefield imaging.
- ✓ Seamless large tissue imaging for fixed and live sample.
- ✓ Image from nm to mm.

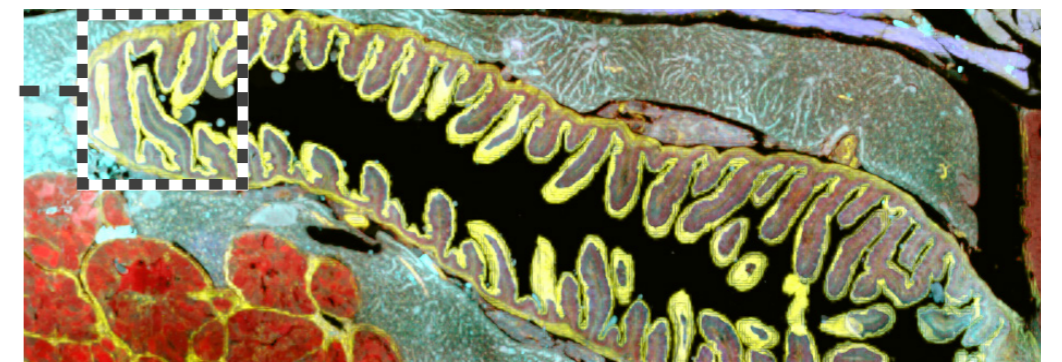

Zebrafish intestine stitched image. Image was acquired using the confocal imaging modality of BC43, with 4 imaging channels, 77 stacks and 28 tiles. The full stitched image is composed of a total of 15,092 images. The deconvolution and stitching options were both activated on the protocol. Sample courtesy of Julien Resseguier, at NorMic, University of Oslo. *Image credit: Claudia Florindo, Andor Technology.*

Application Focus

Neuroscience

BC43 is the perfect workhorse for neuroscience. Imaging experiments commonly require high magnification, for resolution, imaging of large areas to fully understand the architecture and connectivity of this complex tissue. The incredible confocal capture rate of BC43 dramatically reduces imaging time in thick samples delivering faster results.

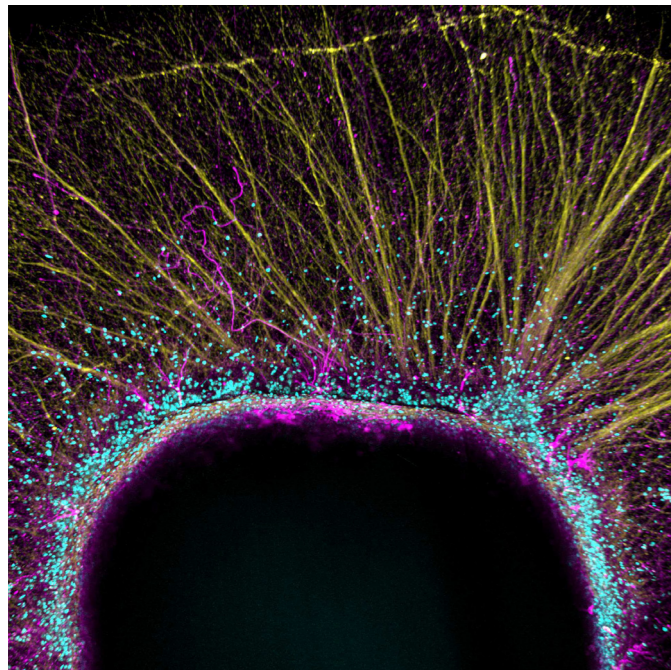

Confocal image of mouse embryonic stem cell derived dopaminergic neurons cultured on top of a collagen hydrogel, expressing tyrosine hydroxylase (in magenta), GAP43 (in yellow) and DNA (in cyan). Image credit: Ana Marote from ICVS, University of Minho and Leonor Ribeiro from INL.

BC43 features for neuroscience:

- ✓ Image both fixed and live samples.
- ✓ Capture deep into cleared brain sections.
- ✓ Developing organoids.
- ✓ Cover the breadth of neuroscience microscopy needs.

Imaris Quantify features for neuroscience:

- ✓ Interact with large 3D images of thick samples.
- ✓ Easy-to-use animation creation.
- ✓ Calculate overlap of proteins.
- ✓ With additional modules use AI tools to identify and trace neurons.

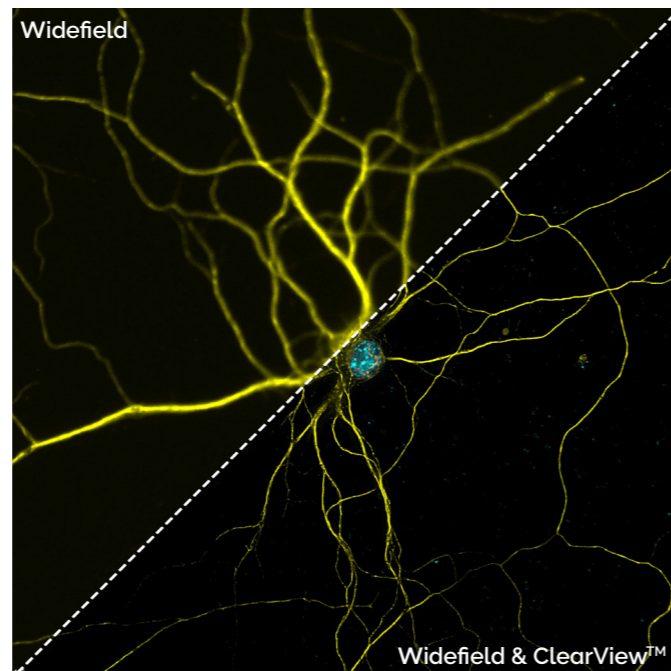

Widefield image primary rat hippocampal neurons, after 15 days in vitro, stained for Tubulin (yellow) and Nucleus (blue). Image credits: Prof. Michael Kiebler; Sabine Thomas; Lehrstuhl für Zellbiologie, Biomedizinisches Centrum (BMC), Medizinische Fakultät, LMU München

Cancer

BC43 is a push-button confocal suitable for the broadest range of cancer experimental models. Capturing stunning images of:

- Subcellular events (e.g. cytoskeletal dynamics).
- Intercellular interactions.
- Migration and division.
- 3D cultures from spheroids and organoids.
- Intact tissue and tumour models.

Use Imaris to analyse key parameters such as distribution of objects around a surface, volume overlap and nearest neighbour analysis. Powerful machine learning classification, and batch mode can be used to deliver reproducible results in time saving workflows.

BC43 and Imaris Quantify features for cancer studies:

- ✓ Image a wide range of cells and tissues.
- ✓ Powerful tools for fast, reproducible results.
- ✓ AI-based tools for easy image analysis.
- ✓ Generate spatial and morphological measurements.
- ✓ Calculate statistics to compare different experimental groups.
- ✓ With additional Imaris modules measure colocalization and track cells.

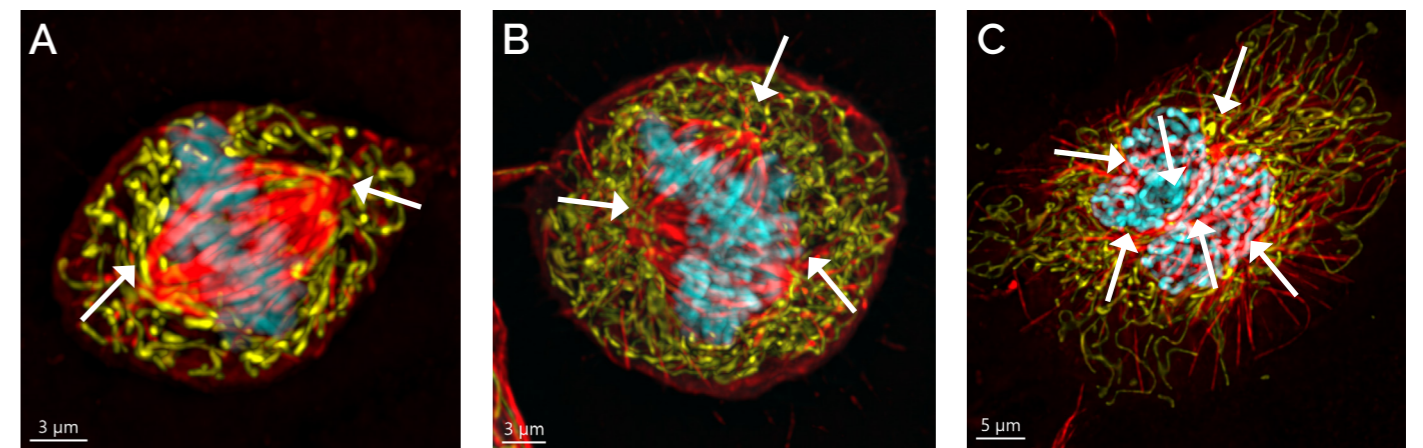

Confocal image of mammalian cells in division. A) Normal cell division. B and C) Abnormal cell division. Cancer cells most often have abnormal cell division. In many cases, these cells do not have a bipolar mitotic spindle (as seen in A) but have multiple poles (as seen in B and C). These multiple poles can lead to abnormal separation of the genomic content, and the daughter cells will have multiple copies of certain genes and no copies of others. This is often named as "genome instability" which is a marker of cancer cells. Image credit: Claudia Florindo, Andor Technology.

BC43 for Core Facilities

Small in size, Big in performance

BC43 is an ideal instrument for a core facility, **easy to operate**, with **multiple microscopy techniques**. It provides great images fast, whatever the sample. Free up your more complex imaging systems for users doing highly specialised experiments.

Many imaging systems can be difficult for users to get comfortable using without extensive training. BC43 is intuitive and easy for even novice microscopists to master. Simple operating procedures, and minimal maintenance allow exceptional productivity from the system. This means **less time training**, **more time imaging** and **more time for core staff running the facility**.

BC43 features for core facilities:

- ✓ Low maintenance.
- ✓ Fast to learn, easy to use, minimal support.
- ✓ Application versatility.



Whole-body flatfish at climax of development. Fish was stained with acetylated tubulin (Yellow) and myosin heavy chain (blue). Confocal image acquired with BC43 using multiple tile acquisition and montage. 30 tiles acquired to compose the image. Each tile had 175 slices, over a Z range of 521 μm . Image credit: Marco Campinho, CBMR Universidade do Algarve and Claudia Florindo, Andor Technology.

Integrated Software Solutions

Fusion

BC43 has an integrated, easy-to-use, and accessible acquisition software interface that delivers high-end imaging. Users benefit from easy protocol set up for multidimensional experiments, such as one-click multi-position-montage and multiwell integration with an intuitive user interface and workflow for protocol set up.

Fusion for BC43 supports real-time GPU-accelerated deconvolution reducing blur and bringing clarity. And the easy-to-use super resolution can provide enhanced detail for demanding experiments. Seamlessly integrated, the 3D stitching allows the montage and visualisation of multiple tiles to give the full context of your sample.

Imaris® Quantify

Each BC43 model includes the introductory Imaris Quantify package. Fusion for BC43 saves files in the Imaris IMS format permitting easy transfer of data into Imaris for further visualisation and image analysis. The Quantify package adds additional visualization and processing features including high-resolution snapshots, creation of multi-dimensional animations, and advanced isosurface rendering of objects within your images.

The Quantify package provides the core quantitative features of Imaris, including AI-based analysis. Whether you are a cancer researcher or neuroscientist there are tools for measuring wide ranging properties of cells and proteins of interest in your samples. Additional application-specific modules of Imaris are available and include specific measurements suited for cell & developmental biologists, neuroscientists and many more disciplines within the life sciences.

To find out more about Imaris please see: imaris.oxinst.com

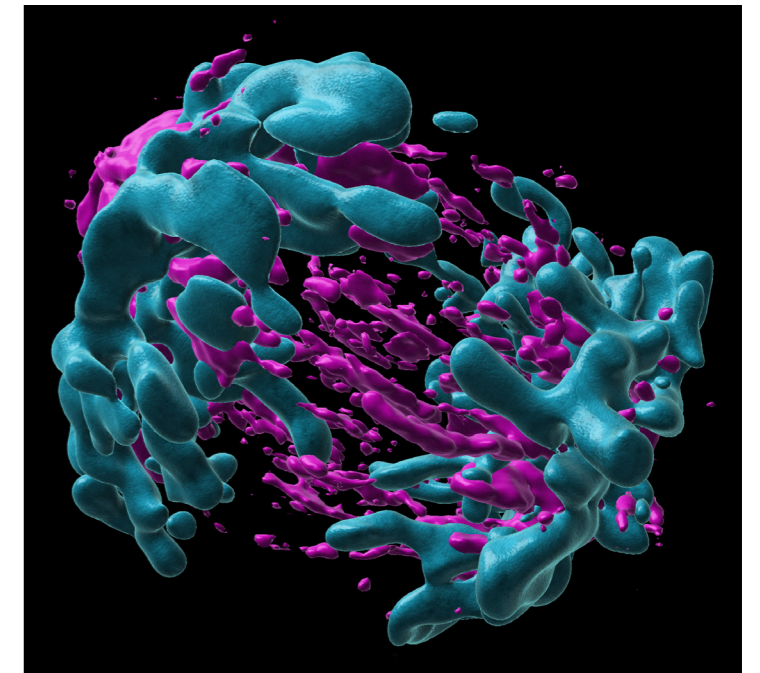

Anaphase in mammalian cells. Image shows an isosurface rendering of an anaphase cell. Image credits: Álvaro Tavares, Ines Baião-Santos, CBMR Universidade do Algarve and Claudia Florindo, Andor Technology.

Key Features of BC43 Family

Hardware Feature	Benefit
High-speed confocal imaging⁵	<ul style="list-style-type: none"> ✓ 3D optical sectioning with high background rejection. Eliminates blur. ✓ Allows deep and large tissue imaging at speed for higher productivity. ✓ Image fast dynamic events in thicker samples.
Widefield imaging	<ul style="list-style-type: none"> ✓ Image thin specimens/structures that do not require optical sectioning. ✓ Highest sensitivity mode for samples super-sensitive to light, or to detect the weakest fluorophores signals.
Differential phase contrast	<ul style="list-style-type: none"> ✓ Capture label-free images. ✓ High contrast Andor transmitted light imaging modality.
Benchtop system	<ul style="list-style-type: none"> ✓ No need for a dark room. Fits in a small bench space in the laboratory. ✓ Set up experiments and image immediately.
Built-in vibration management mechanism	<ul style="list-style-type: none"> ✓ Ensures optimal image quality on your benchtop confocal when working at high-magnification and live-cell time-series.
2x objective for quick sample overview	<ul style="list-style-type: none"> ✓ Quickly navigate your sample with an overview montage and select area to image.
3D ergonomic joystick	<ul style="list-style-type: none"> ✓ Efficient sample navigation, position and focus with adjustable navigation and focus speeds.
Patented Borealis illumination	<ul style="list-style-type: none"> ✓ Optimises illumination uniformity for seamless stitching and more accurate cross-field analysis.
Total imaging flexibility	<ul style="list-style-type: none"> ✓ Image multiple fluorescent channels confocal and/or widefield. ✓ Capture multiple imaging modalities in one protocol; fluorescence with brightfield and Differential Phase Contrast.
sCMOS detector	<ul style="list-style-type: none"> ✓ High sensitivity detector for short exposures and reduced photobleaching. ✓ Maximise number of cells in a single image and capture large samples efficiently with a large field of view e.g. image a 1.85 mm diagonal with 10x objective. ✓ High dynamic range - capture weak and bright signals in a single image without saturation.

Software Feature	Benefit
Easy super resolution⁵	<ul style="list-style-type: none"> ✓ For the highest resolution of subcellular structures in just a few seconds. ✓ Exceptional ease of use with Andor's optimised SRRF-Stream+ technology.
ClearView™ GPU accelerated deconvolution⁵	<ul style="list-style-type: none"> ✓ Reduce blur and increase contrast with deconvolution. ✓ Up to 50x faster processing than non-GPU based deconvolution solutions.
Easy workflow	<ul style="list-style-type: none"> ✓ From sample insertion to image acquisition. Add sample, find sample, set bounds, and acquire the image. No expertise required. ✓ Quick montage - Faster acquisition and experimental setup, improve productivity. Quick 3x3 sample overview, easy to set sample bounds, and center sample for image acquisition with one-click.
Patented Focus Seek & Lock	<ul style="list-style-type: none"> ✓ Focus Seek - makes focusing on your sample easier. ✓ Focus Lock - maintains sample focus during long time-lapse and large sample acquisitions.
Multidimensional acquisition	<ul style="list-style-type: none"> ✓ Acquire multiple imaging dimensions to visualise all the sample features—simultaneous acquisition of time, Z and tile positions.
Multiposition	<ul style="list-style-type: none"> ✓ Acquire multiple positions in a sample and maximise throughput from a single experiment. ✓ Multiposition montage - Acquire multiple montages at independent positions and maximise throughput on fixed or live cell experiments.
Montage & Stitching	<ul style="list-style-type: none"> ✓ Automatically capture large sample data bigger than the field of view. ✓ Stitch huge sample montages in 2D and 3D for the full picture.
Multiwell	<ul style="list-style-type: none"> ✓ Allow multiwell imaging for 6, 12, 24, and 96 well plates—image different treatment, phenotypes, drug screening experiments, etc.
Real-time 3D-rendering	<ul style="list-style-type: none"> ✓ Immediate visual feedback on experimental progress to evaluate data and make appropriate decisions in real-time.
Imaris Quantify	<ul style="list-style-type: none"> ✓ Visualise their 2D/3D/4D images in the world's leading interactive microscopy image analysis software. ✓ Identify and characterize objects within their images via traditional intensity-based and AI methods. ✓ Create high-resolution snapshots and multi-dimensional movies with ease.

Specifications¹

Microscope Unit	BC43
Core Imaging Modes	Widefield epifluorescence Transmitted light - brightfield and Differential Phase Contrast
High-speed confocal⁴⁵	Microlens spinning disk technology for instant confocal imaging.
ClearView™ GPU⁴⁵	Clears image of non-specific sample background signal and improves resolution beyond the normal optical limits.
Super resolution⁴⁵	Increases image resolution to reveal structural detail down to 140-180 nm (depending on sample type, preparation and resulting fluorescence signal to noise).
Imaging Methods	Single colour, multicolour, z-stacking (volume), time-lapse, multi-position, multi-well, montage and 2/3D stitching.
Camera	
Resolution	6.5 µm pixel; 2040 x 1992 (4.1 MP)
QE⁴²	Up to 82%
Field of view (mm)	18.5 mm (diagonal)
Cooling	0°C
Images	16-bit, monochrome
Illumination	
Fluorescence	Fixed configuration of 405 nm, 488 nm, 561 nm, 640 nm
Transmitted light	Broad spectrum visible light LED illumination with monochrome (greyscale) detection
Optics (Objectives)	
Objective Lens Nosepiece	Motorised 5 position turret
Objective Magnifications	BC43 is supplied with 2x objective for sample overview. Select additional supported objective lenses from 10x to 100x magnification.
Precision motorised x, y stage	Travel Range = 110 mm x 80 mm Resolution = 100 nm
Z-Control & Focus	Range = 14.5 mm
Autofocus "Seek & Lock" Technology	Sample "Seek & Lock". Finds focal plane for new sample and maintains focus stability during time-lapse experiments. ⁴³
Sample Vessels Supported	Glass slides (25 by 75 mm); culture dish (35 mm diameter); Multiwell plates (6, 12, 24 & 96); Multiwell chamber coverslip (2, 4, 8). Optimal imaging through glass, imaging through plastic sample vessels are supported with extra-long working distance objectives.
Incubation (option)	Stage-top incubator. Sliding lid for easy sample access and exchange. Objective heater for oil-immersion objectives.
Workstation	
PC	Windows™ 11 operating system 64 GB DDR4 RAM 512 GB SSD Boot drive 16 GB Graphics Card 2 TB Image data storage (option to add more) Fusion control and Imaris Quantify Package software ⁴⁴
Monitor	27 inch

Mechanical Drawings

Units: Millimeters (Inches)

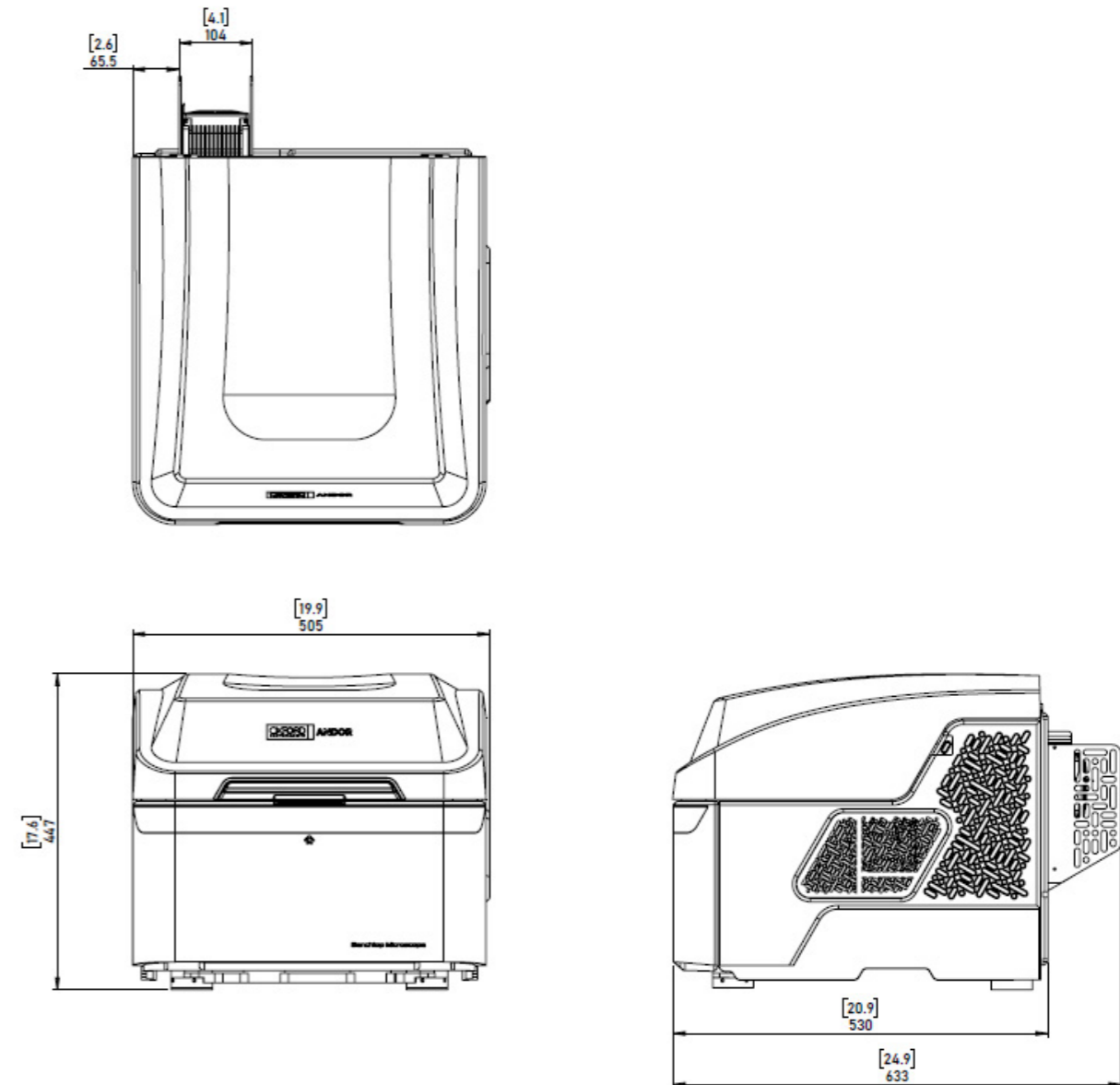

Creating the Optimum Product for you

Please contact your local sales representative who will be able to guide you through the ordering process.

Models

Step 1. Choose the model



Model

Description	Order Code
<p>Andor BC43 Benchtop Microscope.</p> <ul style="list-style-type: none"> Brightfield and Differential Phase Contrast transmitted white light illumination for label-free visualisation and imaging, widefield epifluorescence for low-light imaging. Built-in vibration management to support use on a regular laboratory bench or sturdy table. Patented Focus Seek and Lock to aid sample focus and to retain focus during time-lapse experiments. 2x objective included to aid sample navigation. 4 additional positions available on the motorized turret to add objectives appropriate to your needs. Support up to 100x (choose from list of supported objectives). Excitation lines 405 nm, 488 nm, 561 nm & 638 nm, and emission filter for imaging commonly used fluorophores. Motorised x,y and z axis sample positioning via joystick or software interface. 4.1 MP (6.5 µm pixel, 16-bit) monochrome camera with up to 82% QE, 18.5 mm diagonal field of view. Control software to capture multi-dimensional experiments in x,y,z, time, multi-position, multi-well and montage capture with 2/3D stitching. Workstation supplied see Specifications for full information. Imaris Quantify Package for downstream image editing, multi-dimensional image rendering, snapshots and animations, and AI-based object detection.** 	INS-BM
<p>Andor BM42 Benchtop Microscope. Same as INS-BM but cannot upgrade with confocal.</p>	INS-BM-NU

Optional Imaging Modes or In-field Upgrade Paths

Step 2. Confocal upgrade (not for BM42)



Confocal

Description	Order Code
Confocal module - microlens based spinning disk confocal for fast high-contrast high-quality 3D imaging and deep imaging of thick samples.	INS-CF

Step 3. Super resolution upgrade



Super resolution

Description	Order Code
Super resolution - Adds a easy-to-use super-resolution imaging mode which can achieve resolution down to ~140 nm (depending on sample and strength of labelling). Good for labelling structures like actin filaments, microtubules and vesicles.	INS-SR

Step 4. Deconvolution upgrade



Deconvolution

Description	Order Code
ClearView™ deconvolution - Improves image clarity (removes haze) and resolution. Can be purchased with a widefield model. Please note ClearView is included with all confocal models as standard.	INS-DC

Software & Workstation Options

Step 5. Choose Software Setup



Imaris
Image Analysis
Software

Description	Order Code
Imaris Quantify Package is installed on a separate offline PC for image analysis. NOT node locked to the acquisition workstation. Imaris Viewer will be installed with the BC43 workstation.	IMARIS-QUANT-SEP
Imaris Quantify Package and add-on, if purchased, is installed on the BC43 workstation. Node-locked to the acquisition workstation.	IMARIS-QUANT-ACQ

Step 6. Workstation upgrade options (choose only 1)



Options

Description	Order Code
4 TB data storage upgrade for supplied PC workstation	INS-PC-DRV-4TB
8 TB data storage upgrade for supplied PC workstation	INS-PC-DRV-8TB

Objectives

Step 7. Select up to 4 supported objective lenses



Objectives

Description	NA	Working Distance / mm	Compatibility	Order Code
10x Plan Fluorite objective	0.3	16	Widefield/Confocal	INS-OBJ-10-030
10x Plan Achromat objective	0.45	4	Widefield/Confocal	INS-OBJ-10D-045
20x Plan Achromat objective	0.8	0.8	Widefield/Confocal	INS-OBJ-20D-080
20x S Plan Fluorite objective	0.7	2.3	Widefield/Confocal	INS-OBJ-20-070-LWD
40x Plan Fluorite objective	0.75	0.66	Widefield/Confocal	INS-OBJ-40-075
40x Plan Achromat objective	0.95	0.21	Widefield/Confocal	INS-OBJ-40D-095
40x Plan Achromat silicon oil objective	1.25	0.3	Widefield/Confocal	INS-OBJ-40S-125-SIL
40x Plan Fluorite oil immersion objective	1.3	0.24	Widefield/Confocal	INS-OBJ-40-130-O
60x Plan Achromat oil immersion objective	1.42	0.15	Widefield/Confocal/ Super resolution	INS-OBJ-60D-142-O
100x Plan Achromat oil immersion objective	1.45	0.13	Widefield/Confocal/ Super resolution	INS-OBJ-100D-145-O
20x Plan Fluorite air objective	0.5	2.1	Widefield	INS-OBJ-20-050
10x Plan Fluorite air objective	0.3	15.2	Widefield (supports plastic vessels)	INS-OBJ-10-030-TC
20x Plan Fluorite air objective	0.45	8.2-6.9		INS-OBJ-20-045-TC
40x Plan Fluorite air objective	0.6	3.6-2.8		INS-OBJ-40-060-TC
60x Plan Fluorite air objective	0.7	2.6-1.8		INS-OBJ-60-070-TC

Incubator Options

Step 9. Select the required incubator

	Description	Order Code
 Incubators	Stage-top incubator with humidity module and digitally controlled CO ₂ regulation using a pure CO ₂ source	INS-INC-HUM-CO2-D
	Stage-top incubator with humidity module and manual valve-controlled CO ₂ regulation using a pure CO ₂ source	INS-INC-HUM-CO2-M
	Stage-top incubator with humidity module and manual valve-controlled CO ₂ regulation using a pre-mix air/CO ₂ cylinder	INS-INC-HUM-PRE-M

Step 10a. Select the required incubator sample holders

	Description	Order Code
 Incubator Sample Holders	One position. 1x3 inch chamber slide holder	MSD-INCB-1XGS-M
	One position. 35 mm Petri-dish holder	MSD-INCB-1X35-M
	Two position. 35 mm Petri-dish holder	MSD-INCB-2X35-M
	One position. 1x3 inch chamber slide and #2 35 mm Petri-dish holder	MSD-INCB-GS35-M
	Open frame for multi well plates, suitable for oil immersion objectives	MSD-INCB-MW-OIL
	Two position. 1x3 inch chamber slide holder	MSD-INCB-2XGS-M
	One position. Lab-Tek 1x2 inch chambered cover glass holder	MSD-INCB-1XLBTK-M
	Two position. Lab-Tek 1x2 inch chambered cover glass holder	MSD-INCB-2XLBTK-IIM
	#1 Lab-Tek II 1x2 inch chambered cover glass and #1 50/60 mm Petri-dish holder	MSD-INCB-LBTK-II-60M
	#2 Lab-Tek 1x2 inch chambered cover glass holder	MSD-INCB-2XLBTK-M
	#1 Lab-Tek II 1x2 inch chambered cover glass holder	MSD-INCB-1XLBTK-IIM

Step 10b. Select the required incubator accessories

	Description	Order Code
 Incubator Accessories	Magnetic holder for 35 mm petri dish.	MSD-INCB-35-TL-M
	Lid with thermocouple for local / sample temperature recording at the level of the sample.	MSD-INCB-SENSOR

Maintenance Options

Step 11. Select a maintenance plan (optional)

	Description	Order Code
 Service	Platinum service plan for BC43 confocal models. Priority help desk, all parts, labour, software updates. 1X annual preventative maintenance. Excludes consumables. Replace XX with 12, 24 or 36.	BC43-PLAT-XXMTHS
	Silver service plan for BC43 confocal models. Priority help desk, labour, software updates. 1X annual preventative maintenance. Excludes parts and consumables. Replace XX with 12, 24 or 36.	BC43-SILV-XXMTHS
	Platinum service plan for BM42 and BC43 WF widefield models. Priority help desk, all parts, labour, software updates. 1X annual preventative maintenance. Excludes consumables. Replace XX with 12, 24 or 36.	BC43WF-PLAT-XXMTHS
	Silver service plan for BM42 and BC43 WF widefield models. Priority help desk, labour, software updates. 1X annual preventative maintenance. Excludes parts and consumables. Replace XX with 12, 24 or 36.	BC43WF-SILV-XXMTHS

Service Contract Options - Confocal Models Only

Andor is proud to launch a new Installation Qualification (IQ) / Operational Qualification (OQ) programme for its benchtop microscopes, offering reassurance on long-term performance and repeatability important to data presented in publications. Our OQ programme includes acceptance tests originating from engaging with community groups such as QUAREP-LiMi. The aim, to meet expected standards for cross-industry comparisons to be possible, if other manufacturers offer the same programmes. You can now have a fully supported quality control program from the manufacturer of their microscope with detailed reports detailing actual performance specifications. See our [webpages for further information](#).

Step 12. Select one of our Install or Operational Qualifications (optional)

	Description	Order Code
 Service	Installation Qualification (IQ): A field service engineer will install your new benchtop microscope following a standardized protocol that confirms the instrument is working as expected. An IQ certificate will be provided. Following the IQ install the service engineer will provide basic user training for 2x users and will also provide extra slides and training to perform quality control tests, including laser power.	BC43-IQ
	Installation Qualification (IQ): A field service engineer will install your new benchtop microscope following a standardized protocol that confirms the instrument is working as expected. An IQ certificate will be provided. Operational Qualification (OQ): A field service engineer will perform a comprehensive series of quantitative tests to detail the performance of your benchtop microscope and a certificate provided for reference.	BC43-IQOQ
	Operational Qualification (OQ): A field service engineer will perform a comprehensive series of quantitative tests to detail the performance of your benchtop microscope and a certificate provided for reference. This can be a requested service at any time for reassurance of ongoing performance of your benchtop microscope.	BC43-OQ

Order Today

Need more information? At Andor we are committed to finding the correct solution for you. With a dedicated team of technical advisors, we are able to offer you one-to-one guidance and technical support on all Andor products.

For a full listing of our local sales offices, please see: andor.oxinst.com/contact

Our regional headquarters are:

Europe

Belfast, Northern Ireland
Phone +44 (28) 9023 7126
Fax +44 (28) 9031 0792

Japan

Tokyo
Phone +81 (3) 6744 4703
Fax +81 (3) 3446 8320

North America

Concord, MA, USA
Phone +1 (860) 290 9211
Fax +1 (860) 290 9566

China

Beijing
Phone +86 (10) 5884 7900
Fax +86 (10) 5884 7901

Items shipped with BC43

Base unit, cables and accessories (model as ordered)
PC Workstation and accessories
Fusion and Imaris Quantify Package
User guides in electronic format
Quick start guide
Up to 5 microscope objectives
3D navigation joystick
Microscope slides

Operating & Storage Conditions:

- Indoor use only
- Operating Temperature: 18°C to +25°C ambient
- Storage Temperature: 0°C to 50°C
- Relative Humidity: <70% (non-condensing)
- Size/Weight (BC43)
W x D x H: 505 x 633 x 447 mm and 67.5 kg

Power Requirements:

- Mains Supply: 100 - 240 VAC, 50 - 60 Hz.

System component	Power Consumption / W		
	Standby or sleep	Typical	Max
Unit	12	60 *6	95
PC	1.5	140 *6	230 *7
Monitor	0.5	18	35

Footnotes: Specifications are subject to change without notice

- Figures are typical unless otherwise stated.
- Quantum efficiency as supplied by the sensor manufacturer.
- The Find Coverslip feature is not compatible with the 2x and oil immersion objective lenses. The Focus Stabilization feature cannot be used with the 2x objective lens or plastic sample vessels.
- Imaris Quantify Package software supplied, additional modules will require a separate license.
- Please note confocal, ClearView™ and super resolution functionality will depend on model or upgrade selected.
- Average power consumption when system is actively acquiring data.
- Max power consumption during standard operation.

Laser Safety Information

- It is very hard to access the laser beam with the eye without using a reflective surface to redirect it.
- Class 2 means that the eye aversion response protects against the laser radiation and you have to deliberately stare at it to cause damage. A typical Class 2 product is a laser pointer.

Cover Image: Organoid imaged with BC43. Pancreatic ductal adenocarcinoma cells inside and on top of a 3D hydrogel. DNA is cyan, lamin A/C is Yellow and tubulin is magenta. Image courtesy of Dr Sebastian Amos and Dr Yu-Suk Choi, University of Western Australia.

